

Ferris

POWER PRODUCTS

PM-150

PowerMax 150A High Output Alternator

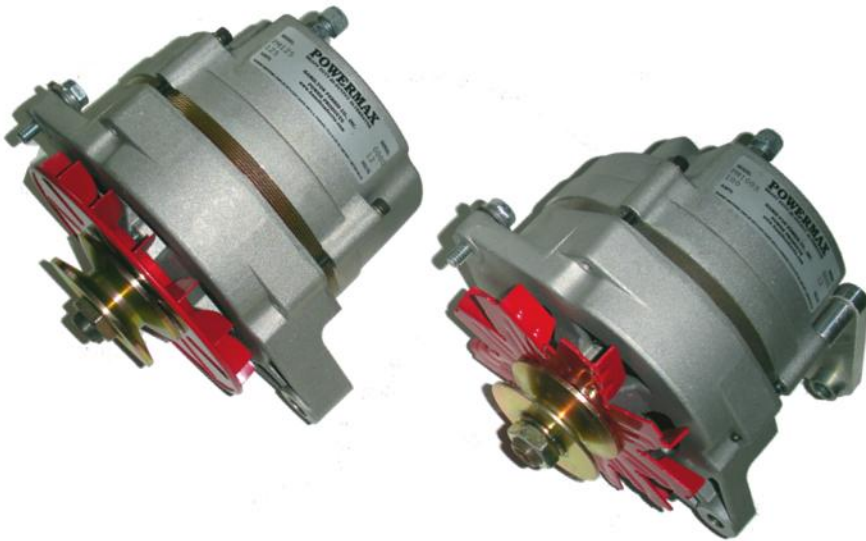

PowerMax 150 Amp Alternator - 12VDC

The **PowerMax** alternator should be the first power source to consider when expanding on or upgrading your charging system.

A **PowerMax** delivers super-high output even at low engine RPM. In combination with a Smart Regulator, you can be sure that your **PowerMax** represents one of the most effective methods of charging your batteries. With 5 - 6 times more charging power than the standard alternator, a **PowerMax** provides reduced engine running time which saves on fuel consumption, noise, heat, and costly engine wear and tear.

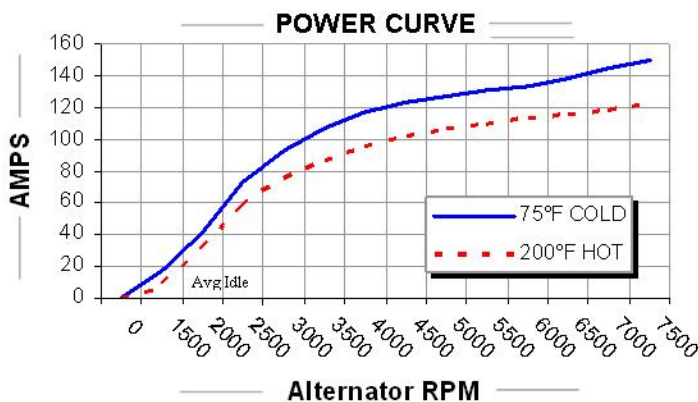

PowerMax Features:

- Heavy Duty, High Performance Alternator
- Industry Standard Small Case Design
- Rated 150 AMPS S.A.E 70F
- Rated 123 AMPS S.A.E 200F
- Externally Regulated
- Precision Balanced High Output Rotor
- Heavy Duty 150 Amp Hand Wound Stator
- Heavy Duty Extended Life Bearings
- Extended Life Copper Impregnated Brushes
- Marine Certified
- 1"ft, 2"ft or 3.15" Saddle Mount Available
- 1 Year Warranty

PowerMax Options:

- 3-Step Smart Regulator
- Cables - Any Size / Length w/ Lugs Installed
- Spike Stop Surge Protector
- Cruising Spares Kits
- **NEW!** - Serpentine Pulley Upgrade Kits

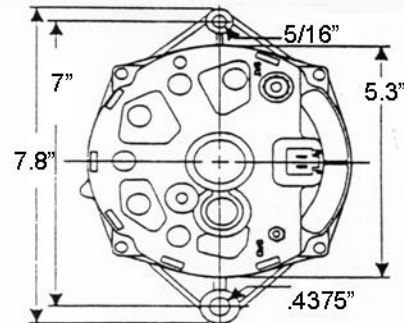

DIMENSIONS

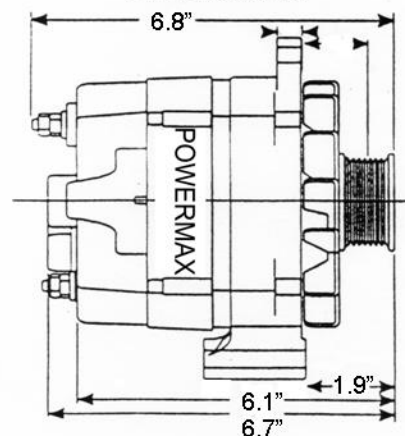

HAMILTON FERRIS CO - POWER PRODUCTS
 3 Angelo Drive, Bourne, Cape Cod, MA 02532 USA
 PHONE: 508-743-9901 | FAX: 508-743-9961 | E-MAIL: sales@hamiltonferris.com